



Count on it.

Operator's Manual

Flex-Force Power System[®] 60V MAX Battery Packs and Chargers

- Model No. 66810—Serial No. 323000001 and Up
- Model No. 88602—Serial No. 323000001 and Up
- Model No. 88605—Serial No. 323000001 and Up
- Model No. 88610—Serial No. 323000001 and Up
- Model No. 88620—Serial No. 323000001 and Up
- Model No. 88625—Serial No. 323000001 and Up
- Model No. 88640—Serial No. 323000001 and Up
- Model No. 88650—Serial No. 323000001 and Up
- Model No. 88660—Serial No. 323000001 and Up
- Model No. 88675—Serial No. 323000001 and Up

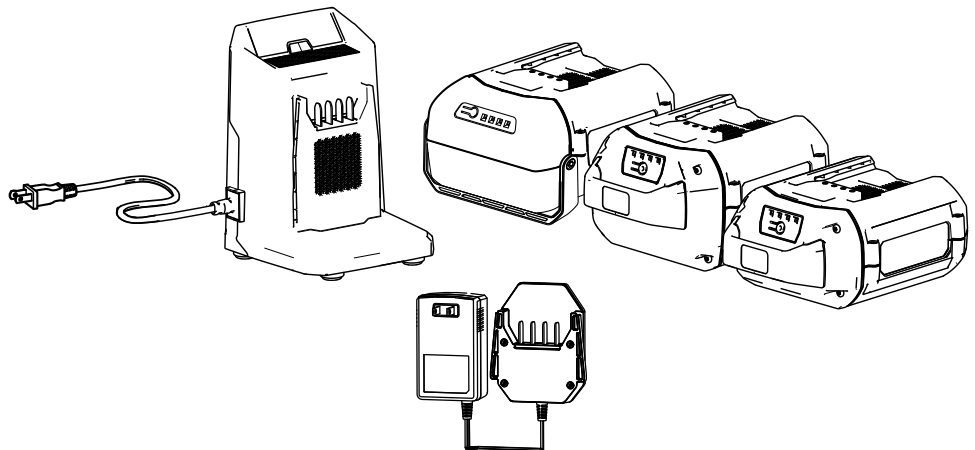

⚠ WARNING

**CALIFORNIA
Proposition 65 Warning**

The power cord on this product contains lead, a chemical known to the State of California to cause birth defects or other reproductive harm. Wash hands after handling.

Use of this product may cause exposure to chemicals known to the State of California to cause cancer, birth defects, or other reproductive harm.

Whenever you need service, genuine the manufacturer parts, or additional information, contact an Authorized Service Dealer or the manufacturer Customer Service and have the model and serial numbers of your product ready. [Figure 1](#) identifies the location of the model and serial numbers on the product. Write the numbers in the space provided.

Important: With your mobile device, you can scan the QR code on the serial number decal (if equipped) to access warranty, parts, and other product information.

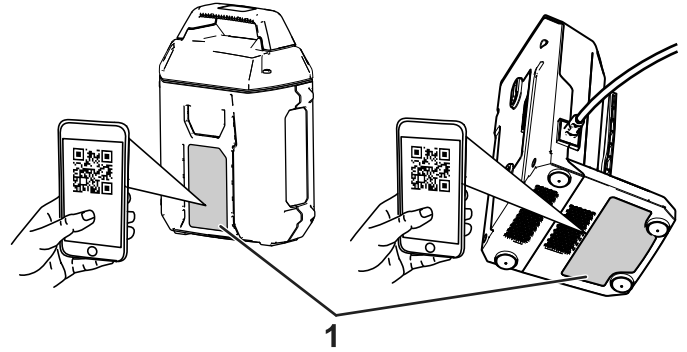

Figure 1

1. Model and serial number location.

Introduction

These chargers and battery packs are intended to be used by homeowners and professional operators. These battery packs are designed to be charged only by Flex-Force 60V lithium-ion battery chargers. These chargers are designed to charge only Flex-Force 60V lithium-ion battery packs. They are not designed to charge any other batteries. Using these products for purposes other than their intended use could prove dangerous to you and bystanders.

Read this information carefully to learn how to operate and maintain your product properly and to avoid injury and product damage. You are responsible for operating the product properly and safely.

Visit www.Toro.com for more information, including safety tips, training materials, accessory information, help finding a dealer, or to register your product.

Model No. _____

Serial No. _____

Safety-Alert Symbol

The safety-alert symbol (Figure 2) shown in this manual and on the machine identifies important safety messages that you must follow to prevent accidents.



Figure 2
Safety-alert symbol

g000502

The safety-alert symbol appears above information that alerts you to unsafe actions or situations and is followed by the word **DANGER**, **WARNING**, or **CAUTION**.

DANGER indicates an imminently hazardous situation which, if not avoided, **will** result in death or serious injury.

WARNING indicates a potentially hazardous situation which, if not avoided, **could** result in death or serious injury.

CAUTION indicates a potentially hazardous situation which, if not avoided, **may** result in minor or moderate injury.

This manual uses two other words to highlight information. **Important** calls attention to special mechanical information and **Note** emphasizes general information worthy of special attention.

Battery Pack

Model	Certified Combinations
66810	This battery is third-party certified for use with all Flex-Force powered tools and chargers.
88620	This battery is third-party certified for use with all Flex-Force powered tools and chargers.
88625	This battery is third-party certified for use with all Flex-Force powered tools and chargers.
88640	This battery is third-party certified for use with all Flex-Force powered tools and chargers.
88650	This battery is third-party certified for use with all Flex-Force powered tools and chargers.
88660	This battery is third-party certified for use with all Flex-Force powered tools and chargers.
88675	This battery is third-party certified for use with all Flex-Force powered tools and chargers.

Safety

IMPORTANT SAFETY INSTRUCTIONS

1. **SAVE THESE INSTRUCTIONS**—This manual contains important safety and operating instructions for Flex-Force 60V lithium-ion battery packs and Flex-Force 60V lithium-ion battery chargers.
2. Before using the battery charger or battery pack, read all the instructions and cautionary markings on the battery charger, battery pack, and product using the battery pack.
3. **CAUTION**—To reduce risk of injury, charge Flex-Force 60V lithium-ion battery packs with Flex-Force 60V lithium-ion battery chargers only. Other brands of battery packs may burst, causing personal injury and damage.
4. **WARNING**—Plugging the battery charger into an outlet that is not 120V can cause a fire or electric shock. Do not plug the battery charger into an outlet other than 120V. For a different style of connection, use an attachment plug adapter of the proper configuration for the power outlet if needed.
5. These devices comply with Part 15 of the FCC rules. Operation is subject to the following 2 conditions: (1) These devices may not cause harmful interference; and (2) these devices must accept any interference received, including interference that may cause undesired operation.

I. Training

1. Do not allow children or untrained people to operate or service this device. Allow only people who are responsible, trained, familiar with the instructions, and physically capable to operate or service the device.
2. Do not allow children to use or play with the battery pack or battery charger; local regulations may restrict the age of the operator.

II. Preparation

1. Use appliances only with specifically designated battery packs. Using other types of battery packs may create a risk of injury and/or fire.
2. Do not use a damaged or modified battery pack or battery charger. It may exhibit unpredictable behavior, resulting in fire, explosion, or risk of injury.
3. If the supply cord to the battery charger is damaged, contact an Authorized Service Dealer to replace it.

III. Operation

1. Charge the battery pack with only the battery charger specified by Toro. A charger suitable for 1 type of battery pack may create a risk of fire when used with another battery pack.
2. Charge the battery pack in a well-ventilated area only.
3. Follow all charging instructions and do not charge the battery pack outside of the temperature range specified in the instructions. Otherwise, you may damage the battery pack and increase the risk of fire.
4. Under abusive conditions, the battery pack may eject liquid; avoid contact. If you accidentally come into contact with the liquid, flush with water. If the liquid contacts your eyes, seek medical help. Liquid ejected from the battery pack may cause irritation or burns.
5. Do not expose a battery pack or tool to fire or excessive temperature. Exposure to fire or temperature above 130°C (265°F) may cause explosion.
6. CAUTION—A mistreated battery pack may present a risk of fire, explosion, or chemical burn.
 - Do not disassemble the battery pack.
 - Replace the battery pack with a genuine Flex-Force battery pack only; using another type of battery pack may cause a fire or risk of injury.
 - Keep battery packs out of the reach of children and in the original packaging until you are ready to use them.

IV. Maintenance and Storage

1. Do not allow children to clean or maintain the battery charger.
2. When the battery pack is not in use, keep it away from metal objects such as paper clips, coins, keys, nails, and screws that can make a connection from 1 terminal to another. Shorting the battery terminals may cause burns or a fire.
3. Do not attempt to repair the battery pack or battery charger. Have an Authorized Service Dealer perform service on the battery pack or battery charger using identical replacement parts to ensure that the product is safely maintained.
4. Check with local codes for possible special battery disposal instructions.

SAVE THESE INSTRUCTIONS

Safety and Instructional Decals



Safety decals and instructions are easily visible to the operator and are located near any area of potential danger. Replace any decal that is damaged or missing.



decal144-3096

144-3096

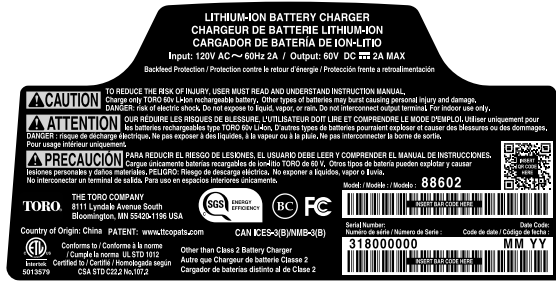

decal137-9462

137-9462

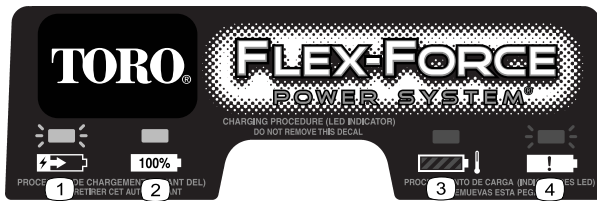

decal137-9463

137-9463

1. The battery pack is charging.
2. The battery pack is fully charged.
3. The battery pack is over or under the appropriate temperature range.
4. Battery pack charging fault

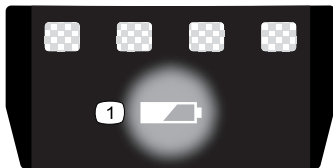

137-9461

decal137-9461

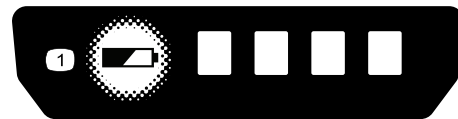

145-8265

decal145-8265

1. Battery charge status

1. Battery charge status

Model 88620



decal140-8471

140-8471

Model 66810



decal145-8260

145-8260

1. Read the *Operator's Manual*.
2. Keep away from open fire or flames.
3. Do not expose to rain.



decal140-8475

140-8475

1. Read the *Operator's Manual*.
2. Call2Recycle® battery recycling program
3. Keep away from open fire or flames.
4. Do not expose to rain.

Model 88625



decal137-9454

137-9454

1. Read the *Operator's Manual*.
2. Call2Recycle® battery recycling program
3. Keep away from open fire or flames.
4. Do not expose to rain.

Model 88640



140-2155

decal140-2155

1. Read the *Operator's Manual*.
2. Call2Recycle® battery recycling program
3. Keep the Lithium Ion battery away from open fire or flames.
4. Do not expose to rain.

Model 88660



137-9455

decal137-9455

1. Read the *Operator's Manual*.
2. Keep away from open fire or flames.
3. Do not expose to rain.

Model 88650



145-1479

decal145-1479

1. Read the *Operator's Manual*.
2. Call2Recycle® battery recycling program
3. Keep away from open fire or flames.
4. Do not expose to rain.

Model 88675



137-9456

decal137-9456

1. Read the *Operator's Manual*.
2. Keep away from open fire or flames.
3. Do not expose to rain.



decal144-3094

144-3094

1. The battery pack is charging.
2. The battery pack is fully charged.
3. The battery pack is over or under the appropriate temperature range.
4. Battery pack charging fault charged.



decal144-3098

144-3098

Setup

Mounting the Battery Charger (Optional)

If desired, mount the battery charger securely on a wall using the wall-mount key holes on the back of the charger.

Mount it indoors (such as a garage or other dry place), near a power outlet, and out of the reach of children.

Refer to [Figure 3](#) for assistance in mounting the charger.

Slide the charger over the appropriately positioned hardware to secure the charger in place (hardware not included).

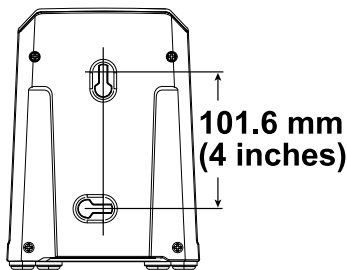

Figure 3

g290534

Product Overview

Specifications

Battery Charger

Model	88602	88605	88610
Type	60V MAX Lithium-Ion Battery Charger	60V MAX Lithium-Ion Battery Rapid Charger	Adapter 60V MAX Lithium-Ion Battery Charger
Input	120V AC ~2.0A, 60Hz	120V AC ~5.0A, 60Hz	120V AC ~2.0A, 60Hz
Output	60V DC 2.0A MAX	60V DC 5.5A MAX	60V DC 1.0A MAX

Battery Pack

Model	88620	88625	88640	88650	88660	88675	66810
Battery pack capacity	2.0 Ah	2.5 Ah	4.0 Ah	5.0 Ah	6.0 Ah	7.5 Ah	10.0 Ah
	108 Wh	135 Wh	216 Wh	270 Wh	324 Wh	405 Wh	540 Wh
Battery manufacturer rating = 60V maximum and 54V nominal. Actual voltage varies with load.							

Appropriate Temperature Ranges

Charge battery pack at	5°C (41°F) to 40°C (104°F)*
Use battery pack at	-30°C (-22°F) to 49°C (120°F)
Store battery pack/charger at	5°C (41°F) to 40°C (104°F)*

*Charging time will increase if you do not charge the battery within this range.

Store the tool, battery pack, and battery charger in an enclosed clean, dry area.

Attachments/Accessories

A selection of Toro approved attachments and accessories is available for use with the machine to enhance and expand its capabilities. Contact your Authorized Service Dealer or authorized Toro distributor or go to www.Toro.com for a list of all approved attachments and accessories.

To ensure optimum performance and continued safety certification of the machine, use only genuine Toro replacement parts and accessories. Replacement parts and accessories made by other manufacturers could be dangerous.

Operation

Charging the Battery Pack

Important: The battery pack is not fully charged when you purchase it. Before using the tool for the first time, place the battery pack in the charger and charge it until the LED display indicates the battery pack is fully charged. Read all safety precautions.

Important: Charge the battery pack only in temperatures that are within the appropriate range; refer to [Specifications \(page 9\)](#).

Note: At any time, press the battery-charge-indicator button on the battery pack to display the current charge (LED indicators).

1. Ensure that the vents on the battery charger are clear of any dust and debris.
2. Line up the cavity in the battery pack ([Figure 4](#)) with the tongue on the charger.
3. Slide the battery pack into the charger until it is fully seated ([Figure 4](#)).
4. To remove the battery pack, slide the battery backward out of the charger.
5. Refer to the following table to interpret the LED indicator light on the battery charger.

Indicator light	Indicates
Off	No battery pack inserted
Green blinking	Battery pack is charging
Green	Battery pack is charged
Red	Battery pack and/or battery charger is over or under the appropriate temperature range
Red blinking	Battery pack charging fault*

*Refer to [Troubleshooting \(page 12\)](#) for more information.

Important: The battery can be left on the charger for short periods between uses.

If the battery will not be used for longer periods, remove the battery from the charger; refer to [Storage \(page 11\)](#).

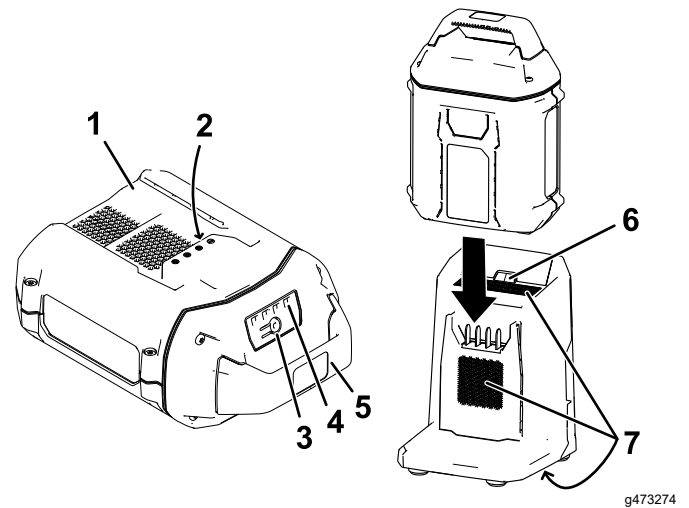

g473274

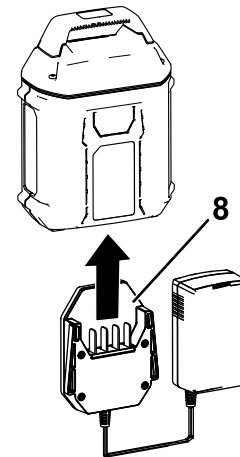

g473698

Figure 4

1. Battery pack cavity
2. Battery pack terminals
3. Battery-charge-indicator button
4. LED indicators (current charge)
5. Handle
6. Charger LED indicator light
7. Charger venting areas
8. Adapter charger

Maintenance

Maintenance and servicing are not required under normal conditions.

When you clean the surface of the equipment, wipe it only with a dry cloth.

Do not disassemble the equipment; if it is damaged, contact your Authorized Service Dealer.

Storage

Important: Store the tool, battery pack, and charger only in temperatures that are within the appropriate range; refer to [Specifications \(page 9\)](#).

Important: If you are storing the battery pack for the off-season, charge it until 2 or 3 LED indicators turn green on the battery. Do not store a fully charged or fully depleted battery. When you are ready to use the machine again, charge the battery pack until the left indicator light turns green on the charger or all 4 LED indicators turn green on the battery.

- Disconnect the product from the power supply (i.e., remove the battery pack) and check for damage after use.
- Clean all foreign material from the product.
- Do not store the charger with the battery pack installed.
- When not in use, store the tool, battery pack, and battery charger out of the reach of children.
- Keep the tool, battery pack, and battery charger away from corrosive agents, such as garden chemicals and de-icing salts.
- To reduce the risk of serious personal injury, do not store the battery pack outside or in vehicles.
- Store the tool, battery pack, and battery charger in an enclosed clean, dry area.

Preparing the Battery Pack for Recycling

Important: Upon removal, cover the terminals of the battery pack with heavy-duty adhesive tape. Do not attempt to destroy or disassemble the battery pack or remove any of its components.



Lithium-ion battery packs labeled with the Call2Recycle seal can be recycled at any participating retailer or battery recycling facility in the Call2Recycle program (US and Canada only). To locate a participating retailer or facility closest to you, please call 1-800-822-8837 or visit www.call2recycle.org. If you cannot locate a participating retailer or facility nearby, or if your rechargeable battery is not labeled with the Call2Recycle seal, please contact your local municipality for more information on how to responsibly recycle the battery. If you are located outside of the US and Canada, please contact your authorized Toro distributor.

Troubleshooting

Perform only the steps described in these instructions. All further inspection, maintenance, and repair work must be performed by an authorized service center or a similarly qualified specialist if you cannot solve the problem yourself.

Problem	Possible Cause	Corrective Action
The battery pack loses charge quickly.	1. The battery pack is over or under the appropriate temperature range.	1. Move the battery pack to a place where it is dry and the temperature is between 5°C (41°F) and 40°C (104°F).
The battery charger is not working.	1. The battery charger is over or under the appropriate temperature range. 2. The outlet that the battery charger is plugged into does not have power.	1. Unplug the battery charger and move it to a place where it is dry and the temperature is between 5°C (41°F) and 40°C (104°F). 2. Contact your licensed electrician to repair the outlet.
The LED indicator light on the battery charger is red.	1. The battery charger and/or battery pack is over or under the appropriate temperature range.	1. Unplug the battery charger and move the battery charger and battery pack to a place where it is dry and the temperature is between 5°C (41°F) and 40°C (104°F).
The LED indicator light on the battery charger is blinking red.	1. There is an error in the communication between the battery pack and the charger. 2. The battery pack is weak.	1. Remove the battery pack from the battery charger, unplug the battery charger from the outlet, and wait 10 seconds. Plug the battery charger into the outlet again and place the battery pack on the battery charger. If the LED indicator light on the battery charger is still blinking red, repeat this procedure again. If the LED indicator light on the battery charger is still blinking red after 2 attempts, properly dispose of the battery pack at a battery recycling facility. 2. Contact your authorized service dealer if the battery is in warranty, or properly dispose of the battery pack at a battery recycling facility.
The tool does not run or does not run continuously.	1. There is moisture on the leads of the battery pack. 2. The battery is not fully installed into the tool.	1. Allow the battery pack to dry or wipe it dry. 2. Remove and then replace the battery into the tool making sure that it is fully installed and latched.

Notes:

Notes:

California Proposition 65 Warning Information

What is this warning?

You may see a product for sale that has a warning label like the following:



WARNING: Cancer and Reproductive Harm—www.p65Warnings.ca.gov.

What is Prop 65?

Prop 65 applies to any company operating in California, selling products in California, or manufacturing products that may be sold in or brought into California. It mandates that the Governor of California maintain and publish a list of chemicals known to cause cancer, birth defects, and/or other reproductive harm. The list, which is updated annually, includes hundreds of chemicals found in many everyday items. The purpose of Prop 65 is to inform the public about exposure to these chemicals.

Prop 65 does not ban the sale of products containing these chemicals but instead requires warnings on any product, product packaging, or literature with the product. Moreover, a Prop 65 warning does not mean that a product is in violation of any product safety standards or requirements. In fact, the California government has clarified that a Prop 65 warning "is not the same as a regulatory decision that a product is 'safe' or 'unsafe.'" Many of these chemicals have been used in everyday products for years without documented harm. For more information, go to <https://oag.ca.gov/prop65/faqs-view-all>.

A Prop 65 warning means that a company has either (1) evaluated the exposure and has concluded that it exceeds the "no significant risk level"; or (2) has chosen to provide a warning based on its understanding about the presence of a listed chemical without attempting to evaluate the exposure.

Does this law apply everywhere?

Prop 65 warnings are required under California law only. These warnings are seen throughout California in a wide range of settings, including but not limited to restaurants, grocery stores, hotels, schools, and hospitals, and on a wide variety of products. Additionally, some online and mail order retailers provide Prop 65 warnings on their websites or in catalogs.

How do the California warnings compare to federal limits?

Prop 65 standards are often more stringent than federal and international standards. There are various substances that require a Prop 65 warning at levels that are far lower than federal action limits. For example, the Prop 65 standard for warnings for lead is 0.5 µg/day, which is well below the federal and international standards.

Why don't all similar products carry the warning?

- Products sold in California require Prop 65 labelling while similar products sold elsewhere do not.
- A company involved in a Prop 65 lawsuit reaching a settlement may be required to use Prop 65 warnings for its products, but other companies making similar products may have no such requirement.
- The enforcement of Prop 65 is inconsistent.
- Companies may elect not to provide warnings because they conclude that they are not required to do so under Prop 65; a lack of warnings for a product does not mean that the product is free of listed chemicals at similar levels.

Why does the manufacturer include this warning?

the manufacturer has chosen to provide consumers with as much information as possible so that they can make informed decisions about the products they buy and use. the manufacturer provides warnings in certain cases based on its knowledge of the presence of one or more listed chemicals without evaluating the level of exposure, as not all the listed chemicals provide exposure limit requirements. While the exposure from the manufacturer products may be negligible or well within the "no significant risk" range, out of an abundance of caution, the manufacturer has elected to provide the Prop 65 warnings. Moreover, if the manufacturer does not provide these warnings, it could be sued by the State of California or by private parties seeking to enforce Prop 65 and subject to substantial penalties.



Count on it.